

TECHNICAL SPECIFICATION / TECHNISCHE BESCHREIBUNG / DESCRIPTION TECHNIQUE

PLATFORM / PLATFORM / PLATFORME

**Batten
Leiste
Câche**

MFC / Melaminplatte /
Panneau mélaminé
12mm

Every bench is equipped
with a metal holder for
the mediabox M02.

Jede Tischplatte
der Plattform enthält
eine Metall
Trägerplatte für
Mediabox M02.

Chaque plate-forme
est doté d'une plaque
en métal pour supporter
le Mediabox M02.

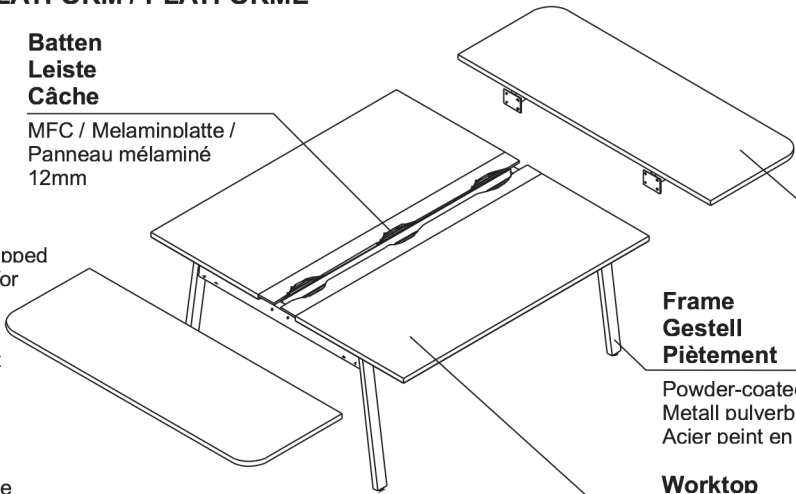

**Extension
Ansatz Tisch
Extension**

MFC / Melaminplatte /
Panneau mélaminé
28mm

**Frame
Gestell
Piètement**

Powder-coated metal element
Metall pulverbeschichtet
Acier peint en poudre

**Worktop
Tischplatte
Plan de travail**

MFC / Melaminplatte /
Panneau mélaminé
28mm

**Batten
Leiste
Câche**

MFC / Melaminplatte /
Panneau mélaminé
12mm

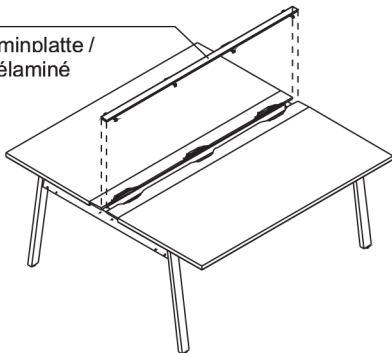

**Pinboards
Stoffpaneel
Cloisons tissus**

Upholstered MFC panel
Melaminplatte gepolstert
Panneau mélaminé avec tissu
47mm

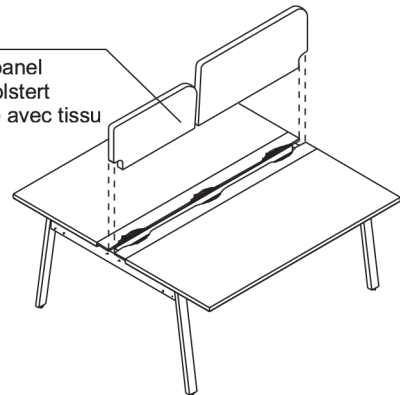

PEDESTAL / CONTAINER / CAISSON

**Body
Korpus
Corps**

MFC / Melaminplatte /
Panneau mélaminé
18mm

**Wheels
Rollen
Roulettes**

- two of them with brakes
 - Bremsrollen 2 Stück
 - dont deux équipés de freins
- Ø 50mm

**Metal drawer
Metallschubladen
Tiroirs en metal**

- system of silent closing ball runners with 35 ka maximum acceptable load. extraction 80%
- "Silent-system"
- Kugelführungsschiene mit einer Belastung von max. 35ka. Auszug 80%.
- glissières télescopiques à billes. Charge jusu'à 35 ka. extraction 80%

**Top
Oberplatte
Top**

MFC / Melaminplatte /
Panneau mélaminé
18mm

- Central lock with antitilt mechanism (only one drawer may be opened at time). foldable key
- Zentralverschluss mit Blockierung gegen das gleichzeitige Ausfahren von mehreren Schubladen. Klappschlüssel
- Clé articulée articulée. Serrure centralisée. assure la fermeture de l'ensemble des tiroirs

Front

MFC / Melaminplatte /
Panneau mélaminé
18mm

**One filina drawer
Aktenschublade
Avec DS.**

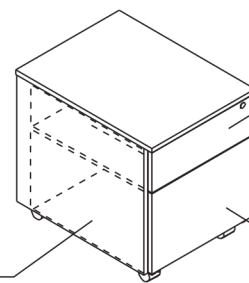

Extraction 80%
Auszug 80%
Extraction 80%

Extraction 100%
Vollauszug
Extraction 100%

TECHNICAL SPECIFICATION / TECHNISCHE BESCHREIBUNG / DESCRIPTION TECHNIQUE

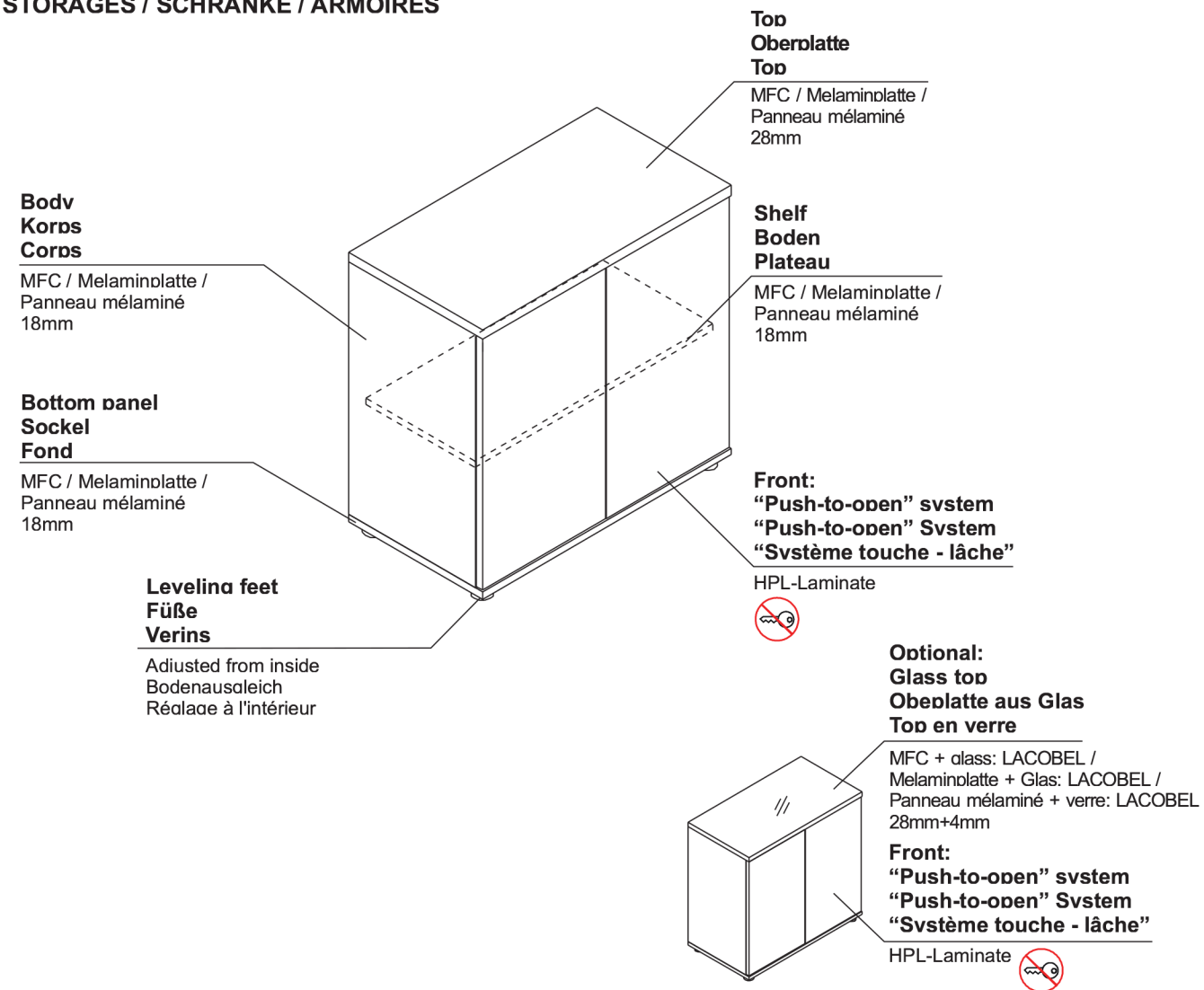

STORAGES / SCHRÄNKE / ARMOIRES



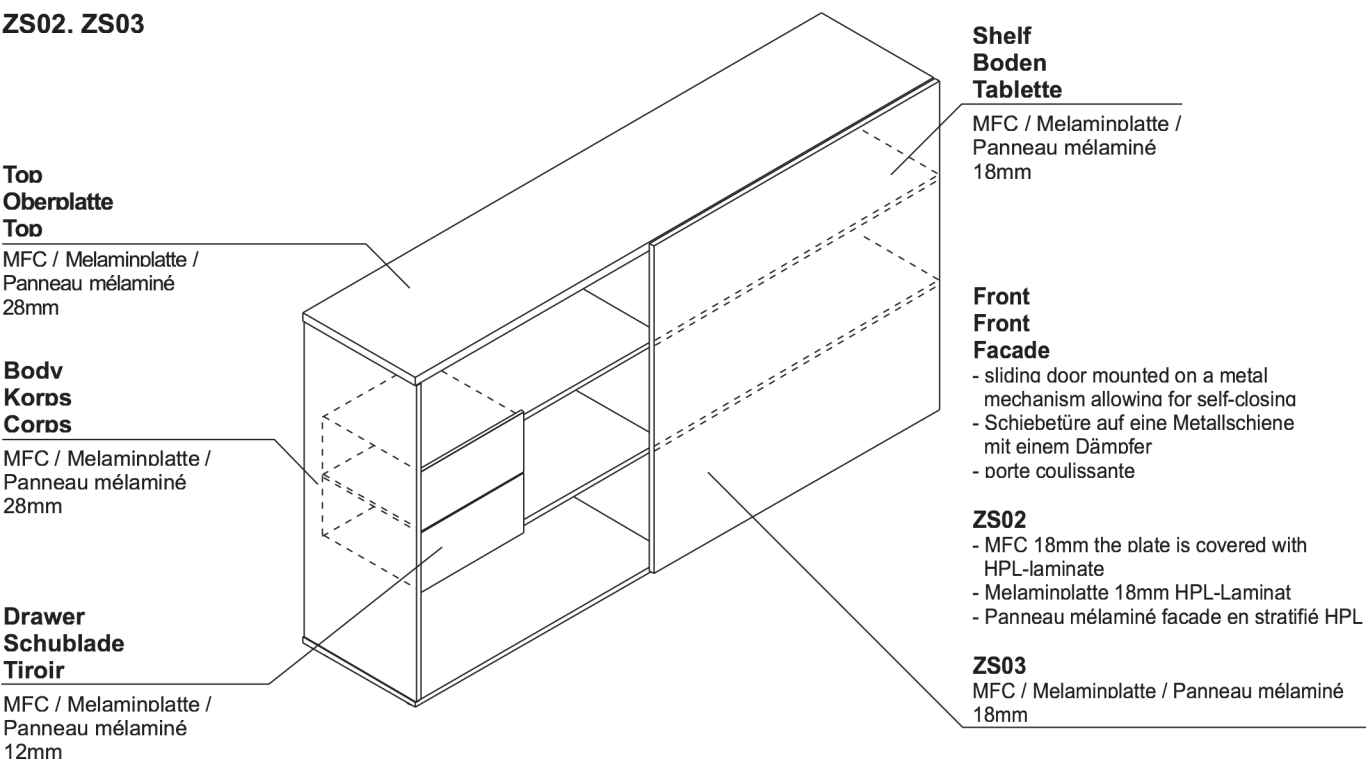

ZS02. ZS03

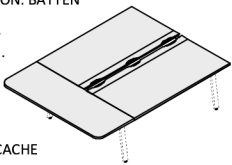
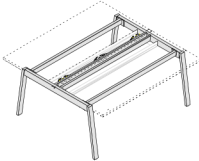
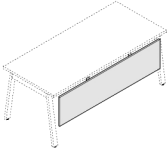
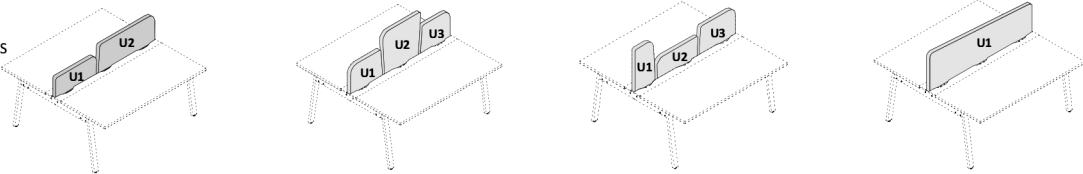

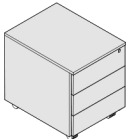
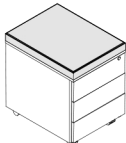
FINISHES / FARBEN / FINITIONS

<p>TOP. EXTENSION. BATTEN TISCHPLATTE. ANSATZTISCH. LEISTE PLAN DE TRAVAIL. EXTENSION. CACHE</p> 	<p>31 – CANADIAN OAK KANADISCHE EICHE CHENE CANADIAN</p> <p>67 – WHITE PASTEL WEIß PASTELL BLANC PASTEL</p>
<p>FRAME GESTELL PIETEMET</p> 	<p>15 – WHITE WEIß BLANC</p>
<p>MODESTY PANEL KNEIBLENDE VOILES DE FOND</p> 	<p>31 – CANADIAN OAK KANADISCHE EICHE CHENE CANADIAN</p> <p>67 – WHITE PASTEL WEIß PASTELL BLANC PASTEL</p>
<p>PINBOARDS STOFFPANEEL CLOISONS TISSUS</p> 	<p>U1 U2 U3</p> <p>NX2 – BEIGE BEIGE BEIGE</p> <p>NX3 – ORANGE ORANGE ORANGE</p> <p>NX5 – RED ROT ROUGE</p> <p>NX9 – GREEN GRÜN VERT</p> <p>NX10 – GREY GRAU GRIS</p> <p>NX15 – NAVY BLUE DUNKELBLAU BLEU MARIN</p>
<p>TOP TISCHPLATTE PLAN</p> 	<p>31 – CANADIAN OAK KANADISCHE EICHE CHENE CANADIAN</p> <p>67 – WHITE PASTEL WEIß PASTELL BLANC PASTEL</p>
<p>FRAME GESTELL PIETEMET</p> 	<p>15 – WHITE WEIß BLANC</p>
<p>PEDESTAL CONTAINER CAISSON</p> 	<p>67 – WHITE PASTEL WEIß PASTELL BLANC PASTEL</p>
<p>PILLOW SKP13 KISSEN SKP13 PANNEAU TISSU SKP13</p> 	<p>NX10 – GREY GRAU GRIS</p>

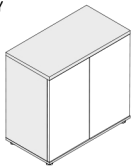
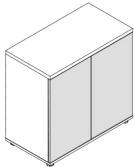
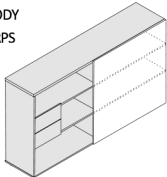
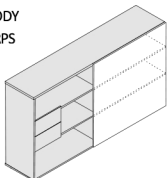
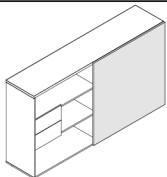
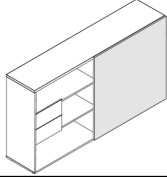
FINISHES / FARBEN / FINITIONS

<p>COUNTER TOP AND BODY OBERPLATTE UND KORPS TOP ET CORPS</p> 	<p>67 – WHITE PASTEL WEIß PASTELL BLANC PASTEL</p>
<p>FRONT HPL HPL - FRONT FRONT STRATIFIE</p> 	<p>72 – HIGH GLOSS LIME 74 – HIGH GLOSS ORANGE GRÜN GLANZ ORANGE GLANZ VERT BRILLANT ORANGE BRILLANT</p> <p>73 – HIGH GLOSS WHITE 82 – HIGH GLOSS RED WEIß GLANZ ROT GLANZ BLANC BRILLANT ROUGE BRILLANT</p>
<p>COUNTER TOP AND BODY OBERPLATTE UND KORPS TOP ET CORPS</p> <p>Z502</p> 	<p>67 – WHITE PASTEL WEIß PASTELL BLANC PASTEL</p> <p>26 – ALUMINIUM SATINATO ALUMINIUM SATINATO ALUMINIUM SATINE</p>
<p>COUNTER TOP AND BODY OBERPLATTE UND KORPS TOP ET CORPS</p> <p>Z503</p> 	<p>67 – WHITE PASTEL WEIß PASTELL BLANC PASTEL</p>
<p>FRONT HPL FRONT HPL FRONT STRATIFIE</p> <p>Z502</p> 	<p>72 – HIGH GLOSS LIME 74 – HIGH GLOSS ORANGE GRÜN GLANZ ORANGE GLANZ VERT BRILLANT ORANGE BRILLANT</p> <p>73 – HIGH GLOSS WHITE 82 – HIGH GLOSS RED WEIß GLANZ ROT GLANZ BLANC BRILLANT ROUGE BRILLANT</p>
<p>FRONT FRONT FRONT</p> <p>Z503</p> 	<p>31 – CANADIAN OAK KANADISCHE EICHE CHENE CANADIAN</p> <p>67 – WHITE PASTEL WEIß PASTELL BLANC PASTEL</p>
<p>DRAWER FOR SCHUBLADEN ZUM TIROIR POUR</p> <p>Z502. Z503</p> 	<p>67 – WHITE PASTEL WEIß PASTELL BLANC PASTEL</p>

PRODUCT ILLUSTRATION OBJEKTANSICHT UND SKIZZE VUE DE PRODUIT	DIMENSIONS / ABMESSUNGEN / DIMENSIONS (mm)			INDEX / SYMBOL	REMARKS BEMERKUNGEN REMARQUES
	width/Breite/ largeur a / a'	depth/Tiefe/ profondeur b / b'	height/Höhe/ hauteur h		

DESK / TISCHPLATTE / BUREAUX

	1600	800	740	BLF16	
	1600	800	740	BLF16M	Mediabox 2 x RJ45/ 4 x 230V. class E. cat. 6
	1800	800	740	BLF18	
	1800	800	740	BLF18M	Mediabox 2 x RJ45/ 4 x 230V. class E. cat. 6

EXTENSION / ANSATZTISCH / EXTENSION

	800	600	740	PLF04	<ul style="list-style-type: none"> - extension with leas for BLF16. BLF18 - Ansatzztisch mit Füßen zum BLF16. BLF18 - extension de bureaux BLF16. BLF18
--	-----	-----	-----	--------------	--

MODESTY PANEL / KNIEBLENDEN / VOILES DE FOND

	1400	18	400	UH4	<ul style="list-style-type: none"> - for BLF16. BLF16M - zum BLF16. BLF16M - voiles de fond BLF16. BLF16M
	1600	18	400	UH5	<ul style="list-style-type: none"> - for BLF18. BLF18M - zum BLF18. BLF18M - voiles de fond BLF18. BLF18M

PLATFORM / PLATFORM / PLATFORME

	1600	1640	740	BLF01	<ul style="list-style-type: none"> - two-user bench - Modulschreibtisch (2 Arbeitsplätze) - configuration 2 postes
	1800	1640	740	BLF11	

PLATFORM / PLATFORM / PLATFORME

	3200	1640	740	BLF02	<ul style="list-style-type: none"> - four-user bench - Modulschreibtisch (4 Arbeitsplätze) - configuration 4 postes
	3600	1640	740	BLF22	
	4800	1640	740	BLF03	<ul style="list-style-type: none"> - six-user bench - Modulschreibtisch (6 Arbeitsplätze) - configuration 6 postes
	5400	1640	740	BLF33	
	1600	1640	740	BLF12	<ul style="list-style-type: none"> - platform elements - Modulschreibtisch - les elements pour multiplier les postes de travail
	1800	1640	740	BLF120	

EXTENSION / ANSATZTISCH / EXTENSION

	1640	600	28	PLF01	<ul style="list-style-type: none"> - extension with mounting elements - Ansatzztisch mit Flachleisten - L'extension
--	------	-----	----	--------------	--

PRODUCT ILLUSTRATION OBJEKTANSICHT UND SKIZZE VUE DE PRODUIT	DIMENSIONS / ABMESSUNGEN / DIMENSIONS (mm)			INDEX / SYMBOL	REMARKS BEMERKUNGEN REMARQUES
	width/Breite/ largeur a / a'	depth/Tiefe/ profondeur b / b'	height/Höhe/ hauteur h		

ASSEMBLY OF A MULTI-USER BENCH / MONTAGE DER PLATFORM / ELEMENTS POUR MULTIPLIER LES POSTES DE TRAVAIL

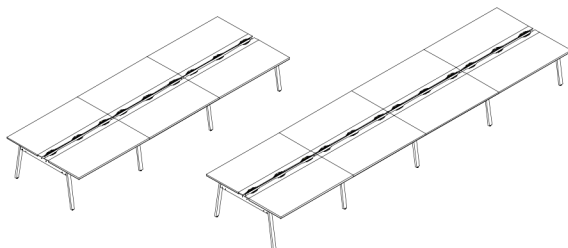
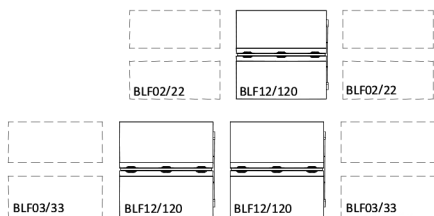

PINBOARDS / STOFFPANEELE / CLOISONS TISSUS

		ZT01		<ul style="list-style-type: none"> - given height over the desktop - bestimmte Höhe über die Schreibtischplatte - hauteur au dessus du plateau de bureau
		ZT11		
		ZT02		
		ZT12		
		ZT03		
		ZT13		
		ZT16		
		ZT18		

PRODUCT ILLUSTRATION OBJEKTANSICHT UND SKIZZE VUE DE PRODUIT	DIMENSIONS / ABMESSUNGEN / DIMENSIONS (mm)			INDEX / SYMBOL	REMARKS BEMERKUNGEN REMARQUES
	width/Breite/ largeur a / a'	depth/Tiefe/ profondeur b / b'	height/Höhe/ hauteur h		

PINBOARDS / STOFFPANEEL / CLOISONS TISSUS

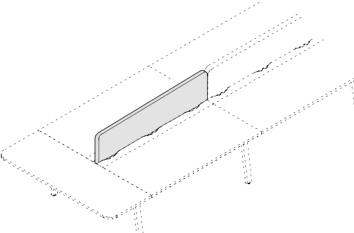
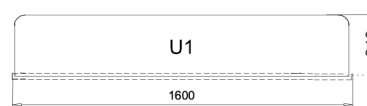
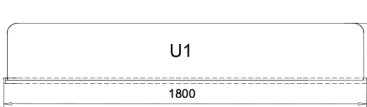
		ZT26		<ul style="list-style-type: none"> - given height over the desktop - bestimmte Höhe über die Schreibtischplatte - hauteur au dessus du plateau de bureau
		ZT28		

ADDITIONAL ELEMENTS / ERGÄNZUNGSELEMENTE / ACCESSOIRES

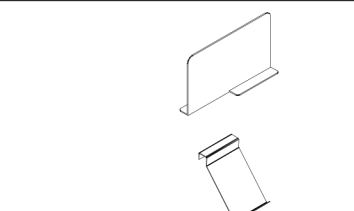
	500	300	5	ZT10	<ul style="list-style-type: none"> - freestanding plexiglass panel - Paneel - panneau séparé - plexiglas
	-	-	-	ZF04	<ul style="list-style-type: none"> - plexiglass reading shelf - Aufhänger - plexiglas - pendentif - plexiglas

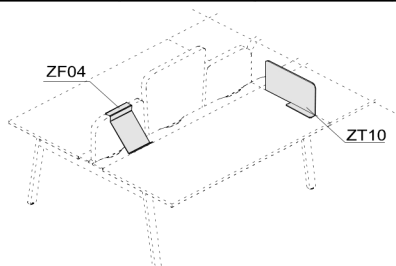

ADDITIONAL ELEMENTS / ERGÄNZUNGSELEMENTE / ACCESSOIRES

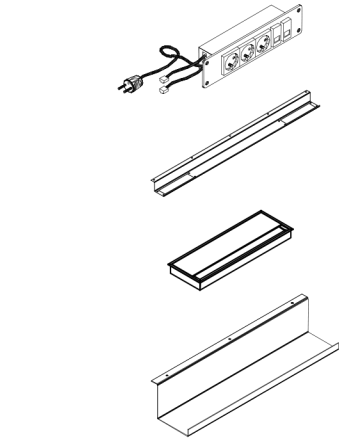
	-	-	-	M02	<ul style="list-style-type: none"> - 3 x 230 V - 2 x RJ45 - class E. cat. 6
	1300	-	-	E60	<ul style="list-style-type: none"> - white - weiß - blanc
	320	110	26	M03	<ul style="list-style-type: none"> - top access - Zugriff von oben - accès par le haut
	600	147	120	E26	<ul style="list-style-type: none"> - cable tray - 15-white - zum Kabelbefestigung unter der Tischplatte - 15-Weiß - caulotte horizontale - 15-blanc

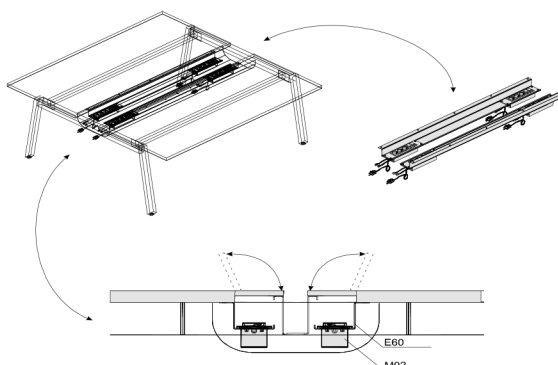

PRODUCT ILLUSTRATION OBJEKTANSICHT UND SKIZZE VUE DE PRODUIT	DIMENSIONS / ABMESSUNGEN / DIMENSIONS (mm)			INDEX / SYMBOL	REMARKS BEMERKUNGEN REMARQUES
	width/Breite/ laroeur a / a'	depth/Tiefe/ profondeur b / b'	height/Höhe/ hauteur h		

ADDITIONAL ELEMENTS / ERGÄNZUNGSELEMENTE / ACCESSOIRES

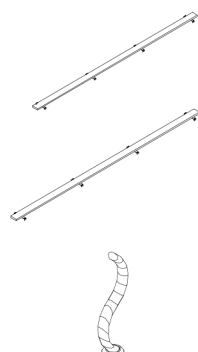
	1600	-	-	PLF02	<ul style="list-style-type: none"> - batten for conference table - Leiste zum Konferenztisch - râlette a construire la table de conférence
	1800	-	-	PLF03	
	140	70	750	S81	<ul style="list-style-type: none"> - vertical cable duct in colour 09-aluminium - Kabelführung 09-Aluminium - passé-cables colonne verticale couleur 09-aluminium

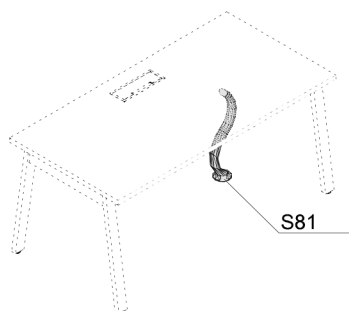

PLF02, PLF03

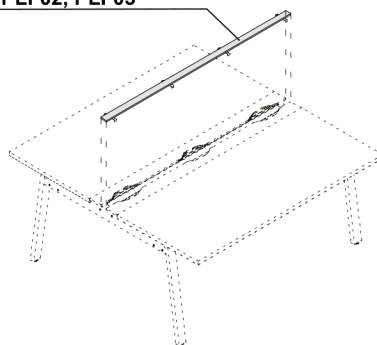

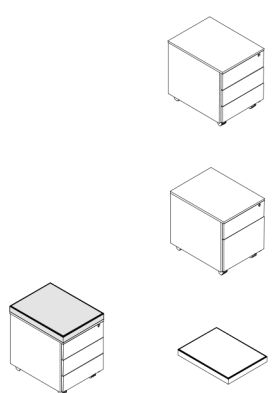

TABLE / TISCH / TABLE BASSE







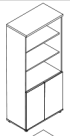

	∅ 800		740	PLF80	
---	-------	--	-----	--------------	--

PEDESTAL / CONTAINER / CAISSON







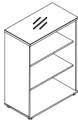

	470	616	580	SLK13	<ul style="list-style-type: none"> - includes pencil trav - mit Materialauszug - avec le plumier
	470	616	580	SLK12	<ul style="list-style-type: none"> - includes pencil trav. one filing drawer - mit Materialauszug Aktenschublade - avec DS.. avec le plumier
	470	616	40	SKP13	<ul style="list-style-type: none"> - pillow for SLK12. SLK13 - Kissen zum SLK12. SLK13 - panneau tissu pour SLK12. SLK13

PRODUCT ILLUSTRATION OBJEKTANSICHT UND SKIZZE VUE DE PRODUIT	DIMENSIONS / ABMESSUNGEN / DIMENSIONS (mm)			INDEX / SYMBOL		
	width/Breite/ larœur a / a'	depth/Tiefe/ profondeur b / b'	height/Höhe/ hauteur h			

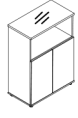
STORAGES WITH HPL FRONT / SCHRÄNKE MIT HPL-FRONT / ARMOIRES AVEC DES FACADES EN STRATIFIE

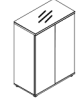
		800	432	1833	A5404H		
		800	432	1833	A5104H		
		800	432	1129	A3404H		
		800	432	1129	A3104H		
		800	432	777	A2104H		

STORAGES WITH HPL FRONT AND GLASS TOP / SCHRÄNKE MIT HPL FRONT UND OBERKRANZ MIT GLAS / ARMOIRES AVEC DES FACADES EN STRATIFIE ET TOPS EN VERRE

		800	432	1134	A3504G		
		800	432	1134	A3404HG		
		800	432	1134	A3104HG		
		800	432	782	A2504G		
		800	432	782	A2104HG		
<ul style="list-style-type: none"> - MFC + glass - Melaminolatte + Glas - panneau mélaminé + verre 		800	432	33	A800GT		



These storages do not have locks.

Ohne Verschluss im Standard.

Armoires ne sont pas équipées d'une serrure.

PRODUCT ILLUSTRATION OBJEKTANSICHT UND SKIZZE VUE DE PRODUIT	DIMENSIONS / ABMESSUNGEN / DIMENSIONS (mm)			INDEX / SYMBOL		
	width/Breite/ largeur a / a'	depth/Tiefe/ profondeur b / b'	height/Höhe/ hauteur h			

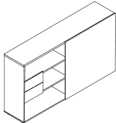
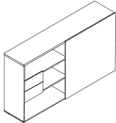
SLIDING DOORS STORAGE / SCHRÄNKE MIT SCHIEBETÜR / ARMOIRES A PORTES COULISSANTES

<ul style="list-style-type: none"> - front: HPL - Front: HPL - front: stratifié 	2000	434	1129	ZS02		
<ul style="list-style-type: none"> - front: MFC - Front: Melaminplatte - front: panneau mélaminé 	2000	434	1129	ZS03		
<ul style="list-style-type: none"> - drawer for ZS02. ZS03 - Schublade zum ZS02. ZS03 - tiroir pour ZS02. ZS03 	428	385	403	ZSZ01		